



# MEETINGS @ EVENTS

Hold it at the Camp Nou



**FCBARCELONA**  
*més que un club*



## Contents //

- 5 The city and the club
- 9 Meetings & Events
- 11 Camp Nou Rooms
- 30 Sports facilities
- 40 M & E services
- 49 Contact details
- 50 FCB Hospitality services
- 53 Location

# An unforgettable city //

Barcelona is a modern, cosmopolitan city that at the same time has inherited many centuries of history. The Mediterranean and its openness to Europe define the character of the capital of Catalonia.

It is in a privileged location, bathed by sea yet surrounded by mountains and well connected by land, sea and air with other international capitals.

It possesses valuable architectural and monumental heritage, in particular from the ages of Gothic and Modernist splendour, including no fewer than nine buildings that have been declared World Heritage Sites.

Since the 1992 Olympic Games, the city has been able to boast an extensive range of first class hotels offering all kinds of comforts in accordance with European standards, famous for the quality of their services and the exquisite treatment that guests receive.

Barcelona is now one of Europe's main destinations for business tourism, congresses and a variety of other events. Its wonderful climate, the excellent quality of its hotel infrastructure and the increase in international trade fairs are highly appreciated factors by visitors to the city.





## More than a club //

FC Barcelona, with more than 100 years of history and more than 160,000 members, is one of football's most respected and admitted clubs. Famous all around the world for its attractive, attacking style, for FC Barcelona's members and fans it is much 'more than a club'. That is the slogan that has historically been used to describe the Barça sentiment and also refers to the club's social commitment and values.

Being a multi-sports club, FC Barcelona has a large variety of fabulous facilities, the most emblematic of all being the Camp Nou, an icon of the city of Barcelona and one of the most legendary stages in the world game. Almost 100,000 spectators enjoy magical evenings in the greatest and most spectacular stadium in Europe, which has a UEFA five star rating.

# The ideal venue for your event //

The FC Barcelona Meetings & Events team can offer you an integral service for the personalised and creative organisation of your events.

Our professionals are multi-functional, being specialists in marketing, communication and PR, with ample experience of the hosting of major events. That means they will understand your needs and have the capacity to adapt to the standards that your company requires.

And all of that in the incomparable and magical setting of such an emblematic club as FC Barcelona.

The club can offer you a wide range of halls and spaces, each with its own exclusive ambience and unique symbolism. You can hire halls and spaces with their own production teams, which will be able to arrange whatever services your event might require, with everything personalised in accordance with your specific needs.

## Corporate events

- Meetings
- Corporate dinners
- Cocktail receptions
- New product presentations
- Showrooms
- Incentives and training

## Sports events

- Company matches and tournaments
- Sports clinics
- Training camps for teams



- LOUNGES
- SPACES
- FACILITIES

1 Auditorium 1899	8 Suppers on the Camp Nou pitch	15 Miniestadi
2 Roma Lounge	9 Grandstand Hall	16 Field 3 artificial turf
3 Presidential Anteroom	10 Camp Nou Terrace	17 Ice Rink
4 Honour Anteroom	11 Grandstand Auditorium	18 Lateral Esplanade
5 Foundation Lounge	12 FCB Museum	
6 Lateral Anteroom	13 FCB Megastore	
7 North Goal Lounge	14 Palau Blaugrana	





# Auditorium 1899 //

Newly constructed 504 m<sup>2</sup> hall in rectangular form and perfectly lit, this spectacular venue will be equipped with two screens and the latest technology audiovisual materials.

The new space will be the venue for congresses organised at the Camp Nou, as well as major club events and presentations of first team players.

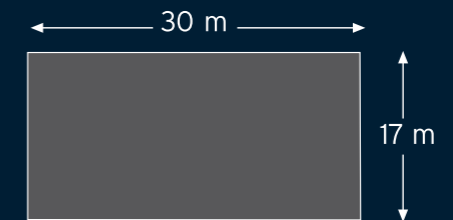

Sizes	Banquet	Cocktail	School	Theatre	Imperial	"U"
504m <sup>2</sup>	350 pax	450 pax	265 pax	500 pax	200 pax	200 pax

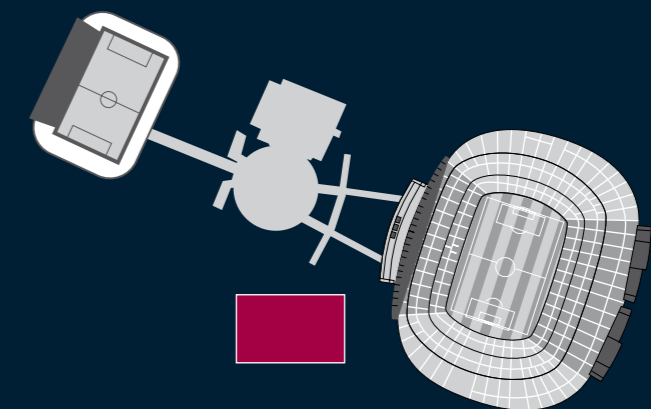

# Grandstand Hall //

Large capacity space for hosting events for up to 1,000 guests. Located by the main entrance to the stadium, it is exceptionally accessible and connected to the inside of the Camp Nou via four different entrances. Events held here can be personalised to achieve a spectacularly high level of sophistication, including assemblies on the steps outside, in the Main Grandstand and on the field of play.



Sizes	Banquet	Cocktail	School	Theatre	Imperial	"U"
1,100m <sup>2</sup>	750 pax	1,000 pax	-	-	-	-







## Camp Nou Terrace //

Spectacular terrace inside the stadium. Events held in this space offer the utmost privacy and a unique view of the pitch and empty stands of the Camp Nou. It is particularly appropriate for welcome drinks, presentations and large format shows. Located in the 1st tier of the grandstand, it can be used for an open air event, shaded from the sun and sheltered from the rain by the architectonics of the Grandstand roof.

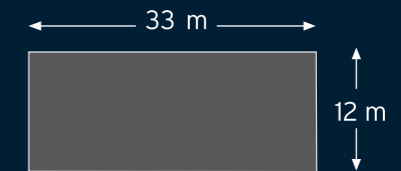
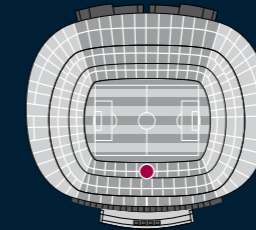

Sizes	Banquet	Cocktail	School	Theatre	Imperial	"U"
400m <sup>2</sup>	300 pax	350 pax	-	1200 pax	-	-

# Roma Lounge //

Recently constructed and with sophisticated décor, this space receives plenty of natural light and offers impressive views of the whole stadium thanks to being located above the Main Grandstand and having such broad windows.

It can be divided into three different zones thanks to the modern partitioning system. It has two bars and a kitchen and is adjacent to ten private boxes that can be used for smaller-scale meetings and for directly accessing the stadium.

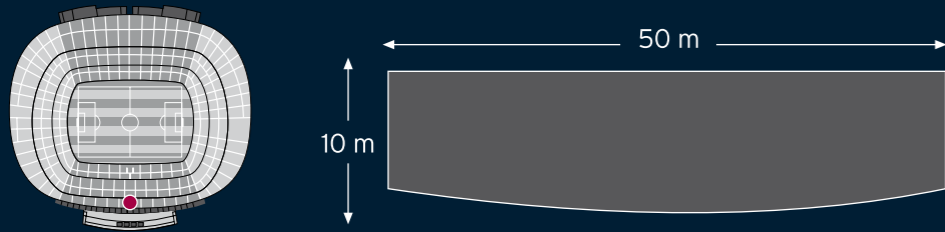

Sizes	Banquet	Cocktail	School	Theatre	Imperial	"U"
520m <sup>2</sup>	240 pax	360 pax	100 pax	150 pax	100 pax	–





# Presidential Anteroom //

The most honourable space in the Camp Nou is the meeting place on match days for numerous personages from all walks of life.

It offers direct access to the most privileged area of the Grandstand, which offers one of the finest views of the stadium.

The lobby was recently remodelled with a new parquet, backlit columns and a bar service.

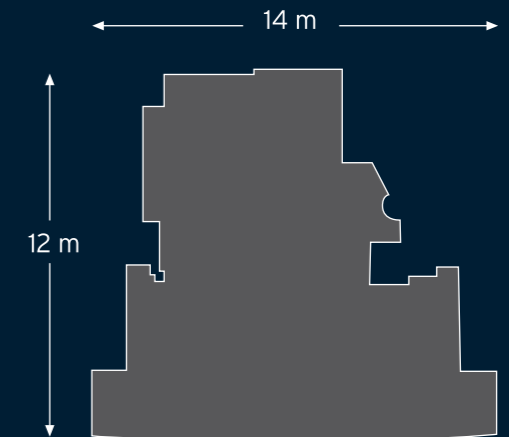
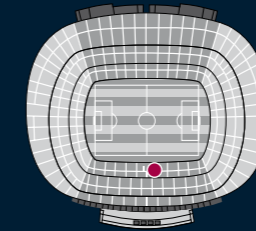

Sizes	Banquet	Cocktail	School	Theatre	Imperial	"U"
182m <sup>2</sup>	80 pax	125 pax	-	-	-	-

# Presidential Area //

## Honour Anteroom

Located one level below the presidential zone, this space offers modern décor using dark woods and noble materials beneath a sloping skylight that combine to create a modern and distinguished ambience.

Fully furnished and equipped with plasma screens, it is remarkably versatile and can be used in combination with the adjacent zones.

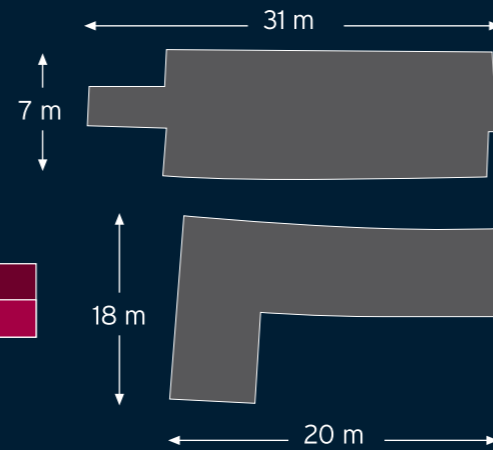
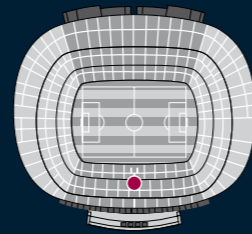

Sizes	Banquet	Cocktail	School	Theatre	Imperial	"U"
217m <sup>2</sup>	110 pax	160 pax	-	-	-	-



## Foundation Lounge

Designed as an extension of the Lobby, this venue offers partial views of the field of play. The ideal place for small-format meetings and cocktail receptions, it is perfectly located just underneath the Presidential Box, with dividing panels and elegant dark wood décor.

Sizes	Banquet	Cocktail	School	Theatre	Imperial	"U"
180m <sup>2</sup>	70 pax	100 pax	50 pax	70 pax	50 pax	45 pax



## North Goal Lounge //

Located in the North Goal zone, with views of La Masia and Tibidabo through a large glass window.

It combines elegant wooden décor with large format photographs of FC Barcelona players in action and several plasma screens are placed around the room.

Sizes	Banquet	Cocktail	School	Theatre	Imperial	"U"
375m <sup>2</sup>	175 pax	260 pax	40 pax	50 pax	175 pax	–

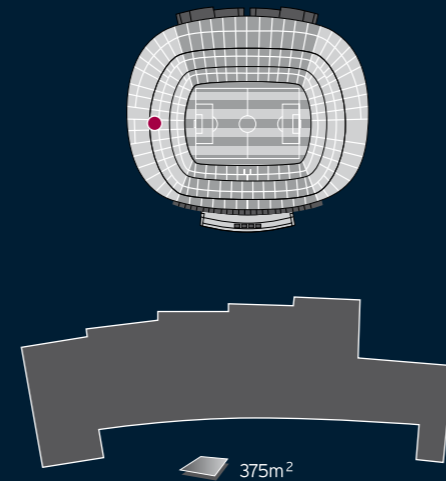

## Grandstand Auditorium //

The grandstand seats configure an improvised but original auditorium where guests can be surprised by a welcome presentation or speech.

The assembly can be personalised by installing a stage in the same terraces or down below on the field of play, and all the required audiovisual materials can be made available, including the option of using the stadium's video scoreboards and large-format projections onto the pitch.

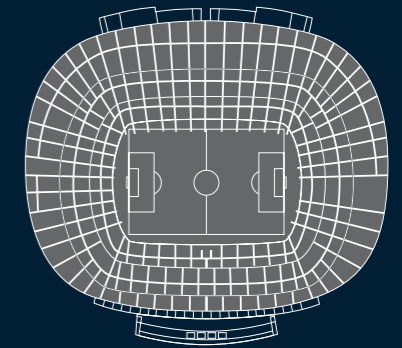

# FCB Museum Space //

The most visited sports museum in the world and also the most frequented in the city is located at the heart of the Grandstand area.

Its two floors can be used to host uniquely staged events. This is an area that oozes 110 years of history and includes a new multimedia zone that is used to relive the most emotional moments in the history of the club in a very special way indeed.

Trophy Area	Sizes	Banquet	Cocktail	School	Theatre	Imperial	"U"
	800m <sup>2</sup>	-	500 pax	-	-	-	-
Audiovisual Area	Sizes	Banquet	Cocktail	School	Theatre	Imperial	"U"
	450m <sup>2</sup>	150 pax	200 pax	-	-	-	-
Museum Area 3.000	Sizes	Banquet	Cocktail	School	Theatre	Imperial	"U"
	3000m <sup>2</sup>	-	2000 pax	-	-	-	-

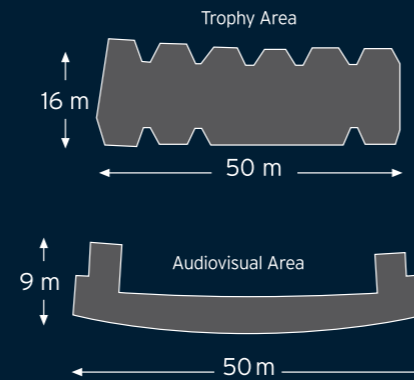
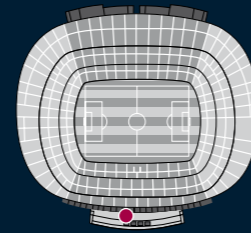

# Lateral Lounge Anteroom //

Located in the lateral zone, this area offers partial views of the stadium terraces and is decorated in bright wooden tones and with different artworks sharing a sporting theme. Its main benefits are functionality and versatility.

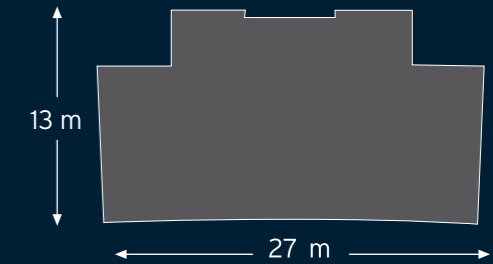
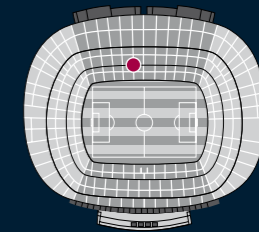

Sizes	Banquet	Cocktail	School	Theatre	Imperial	"U"
350m <sup>2</sup>	160 pax	260 pax	60 pax	80 pax	170 pax	40 pax



# Supper on the Camp Nou pitch //

## Banquet Area

Open air space just in front of the Camp Nou dugouts, ideal for cocktail receptions or gala dinners. Available all year round.

Dimensions	Banquet	Cocktail	School	Theatre	Imperial	"U"
–	150 pax	200 pax	–	–	50 pax	–

## Field of play

The playing field is transformed to host unique suppers at the Camp Nou. Only available in the summer months due to sports fixtures and weather.

Dimensions	Banquet	Cocktail	School	Theatre	Imperial	"U"
150m <sup>2</sup>	70 pax	70 pax	–	–	–	–

Dimensions	Banquet	Cocktail	School	Theatre	Imperial	"U"
400m <sup>2</sup>	300 pax	300 pax	–	–	–	–

Dimensions	Banquet	Cocktail	School	Theatre	Imperial	"U"
1000m <sup>2</sup>	700 pax	700 pax	–	–	–	–

\*For more than 700 people and up to 5.000 please contact

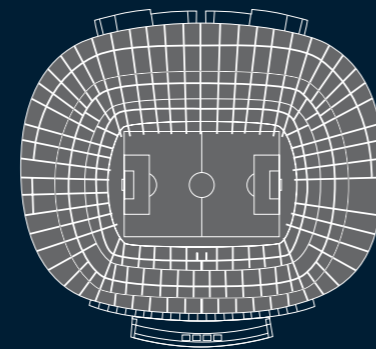



## FCB Megastore space //

An innovative space, another way of doing events.

Located within the Camp Nou, connected to the Museum and the Stadium, the new FCB Megastore has 2.100 square metres spread over three floors. A new feature of this installation is the spectacular 16m long LED display and impressive Chandelier, offering a great way to project images with Stadium shaped bleacher seating, ideal for corporate presentations in a dynamic, modern, and stimulating environment.

The FCB Botiga's facilities are also being offered for the first time to businesses and groups and can accommodate all types of exclusive private events. Select the best option among multiple formats and possibilities: corporate presentations, receptions, snacks, cocktails, and dinner, all while your guests get the opportunity to do some shopping.

Sizes	Cocktail	School	Theatre	Imperial	"U"
2.100 m <sup>2</sup>	1.000 pax	-	100 pax	-	-



# Sports facilities //

	SIZES (m <sup>2</sup> )	MEASUREMENTS
① Camp Nou (field of play)	7.140	105x68
Camp Nou (field of play and surround)	8.200	
② Miniestadi	6.695	103x65
③ Pitch 3 Annex	6.460	95x68
④ Palau Blaugrana Arena	800	40x20
⑤ Ice Rink		
⑥ Sports Complex Joan Gamper	136.839	
Natural Grass Pitches	6.825	105x65
Artificial Grass Pitches	6.825	105x65
Multi-sports Pavilion	1.590	53x30x10

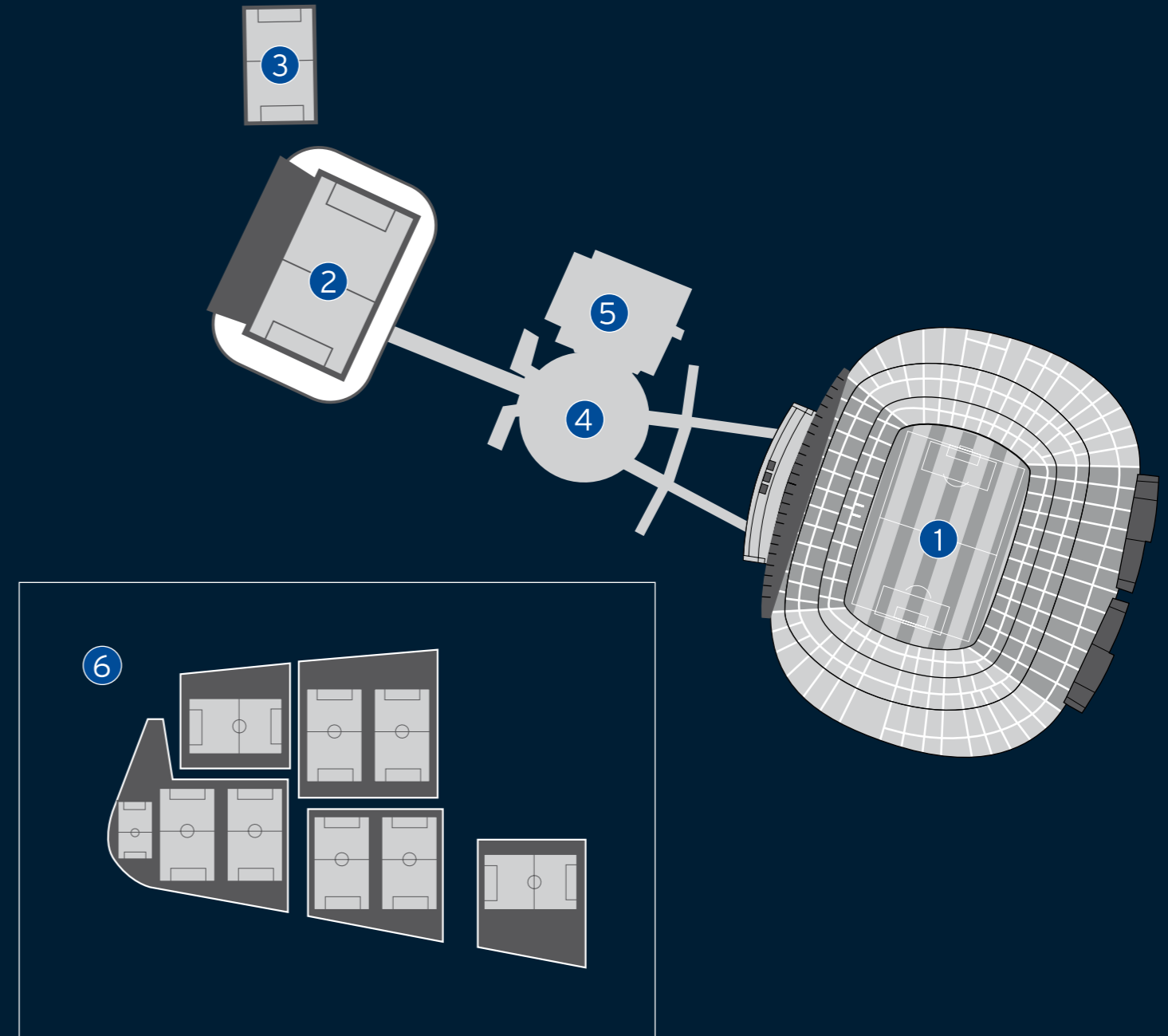



# Camp Nou //

The biggest football stadium in Europe with the capacity for more than 98,000 spectators. It enjoys UEFA 5-star status thanks to its high standards of comfort and security.

Inaugurated in 1957 and remodelled several times since then, it is located in the central neighbourhood of Les Corts, just 15 minutes from the airport and city centre. It has excellent public transport connections and a large parking area.

The grounds are also home to the FC Barcelona Museum, the Palau Blaugrana indoor pavilion, the Ice Rink, the FCBotiga Megastore, the Miniestadi, and many other facilities.

It is ideal for all kinds of events, including large-scale concerts, recordings, product presentations and friendly matches.

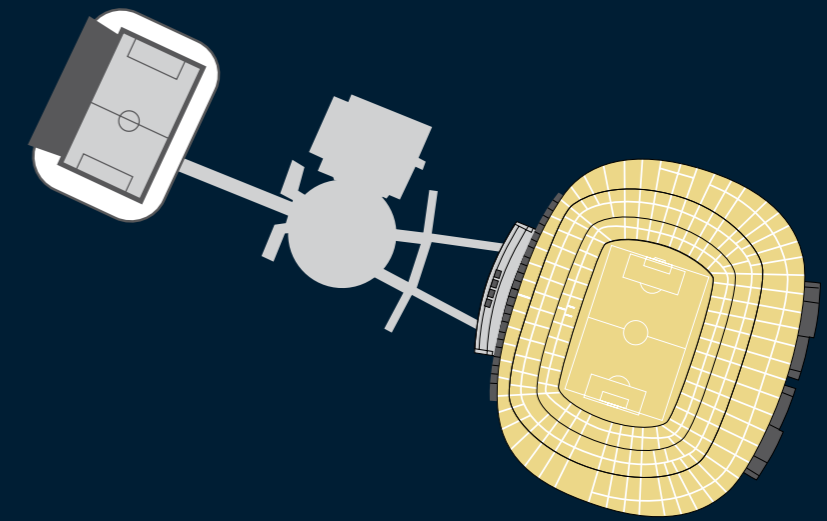

# Miniestadi //

Located next to the Camp Nou and connected to its grounds via an overhead walkway, this is where the club's second team plays home matches.

It has the capacity for more than 15,000 spectators and is ideal for hosting sports events, recordings, projections and meetings.

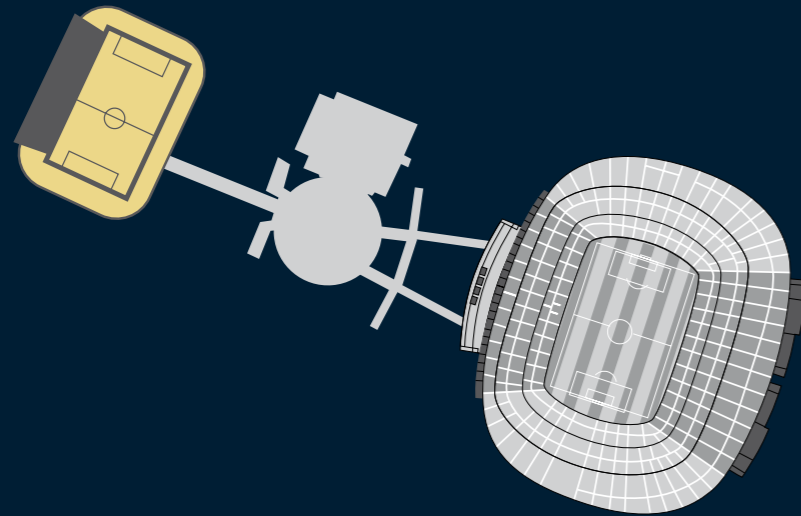



## Sports Complex Joan Gamper //

Inaugurated in 2006 and just 10 minutes away from the Camp Nou, its modern facilities are used for training by all of the club's football teams and many of the other sports sections.

It has five natural grass pitches, four artificial grass pitches, a multi-sports pavilion, gymnasium, services building and pressroom.



# Palau Blaugrana Arena //

The legendary Palau is the home for FC Barcelona's professional basketball, handball, roller hockey and futsal teams. It has the capacity for 7,500 spectators and is famous for its unmistakably spectacular domed roof.

Its facilities include a VIP lounge with the capacity for 100 people.

The Palau is ideal for such events as large-scale meetings, recordings and group activities.

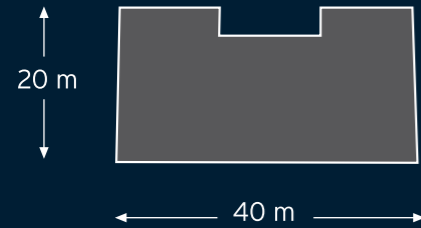

# Ice Rink //

One of the city's classic buildings. Thousands of Barcelonans have come here to enjoy ice skating for fun or for competition since the early 1970s.

Nowadays, it is also used for group activities, recordings and corporate events.



## M&E services



## Catering services //

The club works with the most prestigious catering companies in the city, who ensure exceptionally high product and service quality standards. Their flexibility, versatility and knowledge of the facilities enable them to put on anything from small private meals to major events, offering the best choices in cuisine and services, such as:

- Coffee breaks
- Welcome drinks & snacks
- Cocktail lunches or suppers
- Business meals
- Gala dinners
- Thematic cuisine

# Exclusive services: Weddings at the Camp Nou //

The Camp Nou has spaces and halls with the capacity for between 100 and 800 people that can be hired for wedding banquets and even preceded, if you like, by the civil ceremony itself.

This is a very different way to surprise your wedding guests, using such spaces as Sala Paris, Sala Roma, the Camp Nou Terrace (in summer) or the Grandstand Hall. Certainly, there are plenty of emblematic possibilities to choose from for the celebration of such a special and unique day with family and friends. It also includes such services as parking, photo sessions for the bride and groom in some of the most exclusive areas and the option of using the stadium's video scoreboards to send congratulations messages. The wedding can also incorporate such services as a tour of the stadium and museum for all the guests, the presentation of trophies at the banquet, transfers in the first team bus, etc.





## Exclusive services: Barça You Play //

Barça You Play offers the chance to play a match on the FC Barcelona grounds, making the dream of being a footballer come true for a day. It is the perfect activity for companies and organisations that want to offer a unique experience to their clients, collaborators or employees. It is an original way of optimising public relations, incentives, conventions or business meetings, and does not require any particular level of fitness or football ability.

Barça You Play includes complete personalised uniforms for each player, a match official, coaches from FCB Escola, medical assistance, photographic records, a tour of the Camp Nou Experience for players and spectators, an official diploma from FC Barcelona and a post-match meal in the Camp Nou presidential zone.



# Complementary services: Camp Nou and Museum Tour //

It is so prestigious that it is now considered the most visited thematic sports museum in the world. It is also the most visited museum in Catalonia and one of the finest examples of the club's social and cultural projection.

During the museum tour, visitors get to appreciate the true meaning of the club's origins and history, and the charisma of some of the most memorable stars that have worn the famous colours.

As well as the museum visit itself, there are other complementary options:

- **Camp Nou Experience:** A unique experience to thrill the five senses. The chance to learn more about FC Barcelona's museum, history and values, to discover the most emblematic corners of the Camp Nou and to relive unforgettable moments in the Multimedia Zone.
- **Exclusive night-time openings:** the chance to enjoy exclusive nocturnal visits to the museum will especially surprise your guests as they enjoy a unique and different experience as part of the hosting of a special event.



# Specific complementary services //

**1st team bus:** The club's brand new bus, which is used to transport the first team players, can be used for your event depending on availability.

**Photographs on the pitch:** Immortalise your event with a photograph at pitch level in the Camp Nou, where your guests can enjoy a unique perspective of the stadium and appreciate just what it feels like for the players when they are on the pitch.

**Stadium video scoreboard and megaphones:** 2 LED screens offering more than 70m<sup>2</sup> and 200,000W of sound can be used as a support for any event.

**FC Botiga Megastore/ Merchandising:** On the stadium grounds you will also find the very best official FC Barcelona stores. Here you will find the ideal souvenirs and gifts with which to remember your visit.

**Veteran matches:** FC Barcelona offers the unique possibility of playing against your childhood heroes. Play a match against a team made up of former players on the same facilities used for training by the present-day stars.

**Chat to former players:** Personalised question and answer session with former Barça players, in which they discuss their careers and explain how they are associated to sporting and company values. Their presence is a wonderful opportunity for guests to interact with a living part of FC Barcelona's history.

In short, we can adapt our offer to whatever requirements or needs you have in order to make your event even more special than ever.





## General complementary services //

To produce a better quality event than ever and make your work easier, FC Barcelona can also offer additional services:

**Photographs and video:** Professionals with ample experience of immortalising events and getting the very best results.

**Sound and light:** All the resources you need to create the perfect atmosphere for your event.

**Signs and corporate image:** The utmost flexibility for personalising the venues with your corporate image.

**Audiovisual equipment:** We have video projection and audio systems for use in your events and presentations.

**Hostesses:** The best agencies in Barcelona are regular collaborators with the club and know all about the facilities and protocols required.

## Contact details //

**For further information, detailed costs, availability and reservations:**

**E-mail:** [events@fcbarcelona.cat](mailto:events@fcbarcelona.cat)

**Telephones:** 93 496 37 94  
93 496 36 35  
93 496 36 00

**Switchboard:** 902 1899 00

**Website:** [www.fcbevents.com](http://www.fcbevents.com)

# FCB Hospitality services



Imagine enjoying the experience of an FC Barcelona match from a privileged position, with an unbeatable view of the pitch and a whole range of special comforts in an exquisite setting. Camp Nou VIP Tickets, a product forming part of the FC Barcelona VIP ZONE programme, provide you with:

## Per match

This option enables you to purchase VIP tickets for one-off matches. On offer are a wide range of exclusive seats to satisfy all your company's hospitality and PR requirements. This includes a catering service, hostesses, exclusive entry to the VIP lounge, TV circuit and match line-ups.

## Per season

This option enables you to enjoy VIP seats or a private box for every game in a season. You will also join FC Barcelona's Club Empresa programme. Exclusively on offer, with all the associated comforts, are options for your company to select the level of privacy, service and comfort that is best adapted to your individual needs.

## Palau Blaugrana Hospitality (basketball)

With FC Barcelona Regal, you can enjoy the finest basketball in Europe in the perfect setting. There is nothing better than getting the very finest seats to experience the pure essence of basketball. In the most exclusive sections of the Palau Blaugrana you will enjoy every comfort, as well as access to the VIP lounge.

## Palau Box

Seats located next to the Presidential Box that offer an unbeatable tactical view of the court, all in an exclusive setting shared with important personages and former FCB players.

Here you will enjoy every game in the Euroleague (Regular Season, Top 16 and play-offs) and the ACB League (regular season and play-offs). Guaranteed minimum of 25 matches.

## Vip Seating

Chairs placed courtside. From this area you feel like a player, the best way to experience the event firsthand.



## Location //

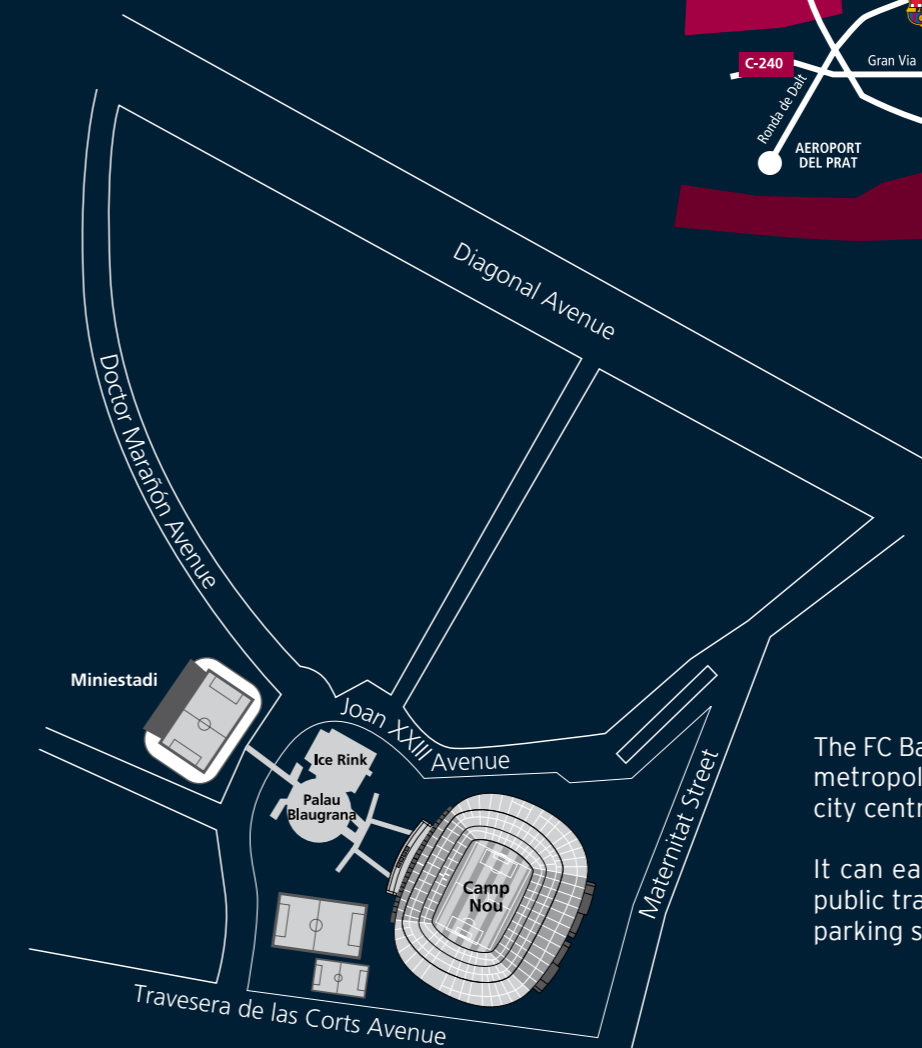

The FC Barcelona ground is in the heart of the metropolitan area, just 10 minutes from the city centre and 15 minutes from the airport.

It can easily be reached using any form of public transport, taxi or private vehicle, with parking spaces available on the grounds.



**FCBARCELONA**  
*més que un club*

events@fcbarcelona.cat

93 496 37 94 • 93 496 36 35

www.fcbevents.com

902 1899 00

FC Barcelona official sponsors:

